



02 9452-3566

[sales@getpacked.com.au](mailto:sales@getpacked.com.au)

# SPARE PARTS LIST FOR THE ELECTRONIC WATER ACTIVATED TAPE DISPENSER

## 2-WA-D-EG-100



## Contents

Number	Name		Page
1	Spare Part List	.....	1
2	Sub-assembly List	.....	5
3	Left Side Cover Assembly	.....	6
4	Heating Module Assembly	.....	7
5	Driven Wheel Assembly	.....	8
6	Cutter Lifting Linkage Assembly	.....	9
7	Driving Wheel Assembly	.....	10
8	Harness List	.....	11

Spare Part List							
Number	Category	Part Number	New P/N#	Part Name	Diagram	Fasteners	Qty
1	Component	14A04028	14A04028	Water Bottle			1
2	Component	14A04026	14A04026	Water Bottle Cover			1
3	Component	14A04019	09C02022	100V AC Motor(100V)		11A0101439*3	1
		14A04008	09C02035	110V AC Motor(110V)			1
		14A04004	09C02026	220V AC Motor(220V)			1
4	Component	07A0103031	07A0103154	Timing Belt			1
5	Component	07A0103032	07A0103032	Timing Pulley		11A0101432*2	2
6	Component	14A04032	14A04032	Heating Module			1



7	Component	14A04039	14A04039	Water Box			1
8	Component	07A0105269	07A0105269	Brush			1
9	Component	14A04036	14A04036	Tension Spring			2
10	Component	14A04017	09C02023	90V Electromagnet(100V)		11A0101438*8	1
		14A04020	09C02027	100V Electromagnet(110V)			1
		14A04033	09C02028	200V Electromagnet(220V)			1
11	Component	08A0105141	08C0202001	Photoelectric Slot Sensor		11A0101435*2	1
12	Component	05A0104004	05A0104004	Tape Position Limit Plate			2
13	Component	14A04014	09C01076	Cover-opening Detection Sensor Wire		11A0101165*2 11A0103165*2	1

14	Component	14A04012	14A04012	Fixed Cutter			1
15	Component	11A0108029	11A0108029	Nylon Sleeve			2
16	Component	11A0108034	11A0108034	Split pin			3
17	Component	11A0108030	07A0105410	Stainless Steel Parallel Pin			1
18	Component	11A0108031	07A0105541	Stainless Steel Parallel Pin			2
19	Component	07A0105099	07A0105099	Rubber Coated Wheel		02A0104002*1	1
20	Component	14A04047	14A04047	Running Cutter			1
21	Component	14A04038	14A04038	Control Board		11A0101435*4	1
22	Component	08A0105382	08C0502005	Power Supply		11A0101435*2	1

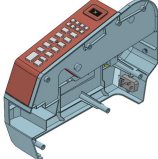
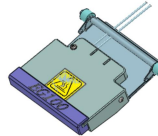
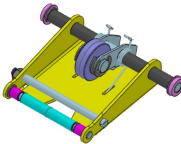
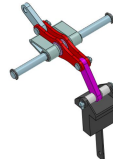
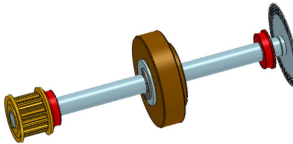

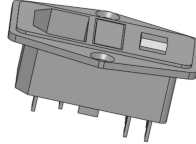
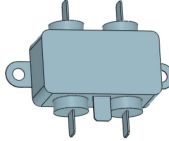
23	Component	14A04015	09C03031	Pedal Four-core Circular Plug Signal Wire			1
24	Component	08A0105795	08C1103004	8A Fuse(100V/110V)			1
		08A0105086	08C1103002	4A Fuse(220V)			1
25	Component	14A04037	14A04037	Screen			1
26	Component	07A0105165	07A0105165	Colored Silicone Button Panel(SI)			1
		07A0105256	07A0105256	Colored Silicone Button Panel(inch)			1
27	Component	07A0105101	07A0105101	Membrane Keypad			1

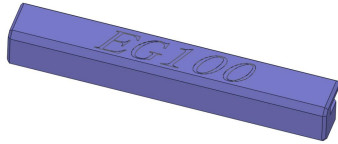
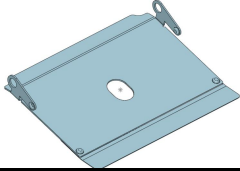
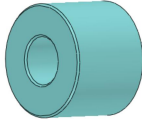
Sub-assembly Lsit						
Number	Category	Part Number	Part Name	Diagram	Fasteners	Qty
A	Assembly		Left Side Cover Assembly		11A0101301*7	1
B	Assembly		Heating Module Assembly			1
C	Assembly		Driven Wheel Assembly			1
D	Assembly	14A04046	Cutter Lifting Linkage Assembly			1
E	Assembly		Driving Wheel Assembly			1

Number	Category	Part Number	New P/N#	Part Name	Diagram	Fasteners	Qty
A	Assembly			Left Side Cover Assembly			1
A.1	Component	08A0105006	08C0802003	Power Socket Wire		11A0101282*2	1
A.2	Component	08A0105604	08C0602001	Filter		11A0101438*2	1

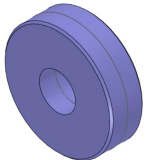
Number	Category	Part Number	Part Name	Diagram	Fasteners	Qty
B	Assembly		Heating Module Assembly			1
B.1	Component	02A0104021	External Counterweight		11A0101300*3	1
B.2	Component	05A0104050	Lower Plate of Heating Runner			1
B.3	Component	02A0104007	Heating Module Bushing			1
B.4	Component	02A0104006	Heating Module Shaft			1

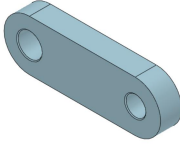
Number	Category	Part Number	Part Name	Diagram	Fasteners	Qty
C	Assembly		Driven Wheel Assembly			1
C.1	Component	08A0101065	Flanged Bearing			2
C.2	Component	08A0101063	Deep Groove Ball Bearing			1

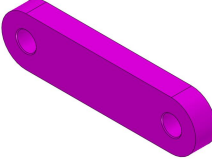
Number	Category	Part Number	Part Name	Diagram	Fasteners	Qty
D	Assembly		Cutter Lifting Linkage Assembly			1
D.1	Component	05B0104008	Left Connecting Rod LP			1
D.2	Component	05B0104009	Intermediate Connecting Rod LP			2
D.3	Component	08A0101065	Flanged Bearing			2
D.4	Component	05B0104005	Right Connecting Rod LP			1

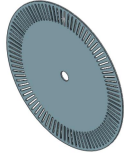
Number	Category	Part Number	Part Name	Diagram	Fasteners	Qty
E	Assembly		Driving Wheel Assembly			1
E.1	Component	08A0101064	Flanged Bearing			2
E.2	Component	08A0104393	Encoding Disc		11A0103175*1 11A0101464*1	1



02 9452-3566

sales@getpacked.com.au

### Harness List

Number	Part Number	New P/N#	Part Name	Lable	Qty
1	09A0101036	09B03074	Power Plug Jump Wire, L0	LO	1
2	09A0101037	09B03008	Power Plug Jump Wire, N0	NO	1
3	09A0104002	09B03108	24V Power Wire	24V;V+;GED;V-	1
4	09A0104011	09B03109	220V Power Cord Connecting Cable, 1	L;N;PE	1
5	09A0104012	09B03110	220V Power Cord Connecting Cable, 2	L;N;PE	1
6	09A0104014	09B02011	LCD and Keyboard Signal Wire	/	1
7	09A0104016	09B03111	220V Power Cord Connecting Cable, 3	L;N	1
8	09A0104017	09B03112	220V Power Cord Connecting Cable, 4	PE	1